

ABISKO

Claesson Koivisto Rune

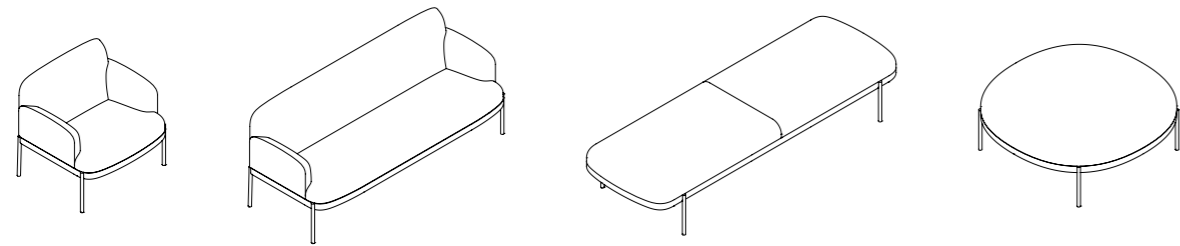

ARMCHAIR
POLTRONA - FAUTEUIL

2 SEATER SOFA
DIVANO - CANAPÉ

BENCH
PANCA - BANC

ROUND BENCH
PANCA CIRCOLARE - BANC CIRCULAIRE

COLORS AND MATERIALS

COLORI E MATERIALI - COULEURS ET MATÉRIAUX

WOOD LEGNO - BOIS



oakwood
rovere
chêne

The standard finish is oakwood.
Customized RAL colors are available upon request.

La finitura standard è il rovere.
Colori RAL personalizzati sono disponibili su richiesta.

La finition standard est le chêne.
Sur demande, d'autres couleurs spéciales sont disponibles en RAL.

STEEL FEET PIEDI IN ACCIAIO - PIEDS EN ACIER



Click on the icon to see the standard RAL finishings for the steel bases on the dedicated page. Customized RAL colors finishings are available upon request.

Clicca sull'icona per vedere le finiture RAL standard delle basi in acciaio sulla pagina dedicata. Su richiesta sono disponibili colorazioni customizzate su altre tinte RAL.

Cliquez sur l'icône pour voir les finitions RAL standard des bases en acier sur la page dédiée. Des couleurs RAL personnalisées sont disponibles sur demande.

TECHNICAL FEATURES

SPECIFICHE TECNICHE - SPÉCIFICATIONS TECHNIQUES

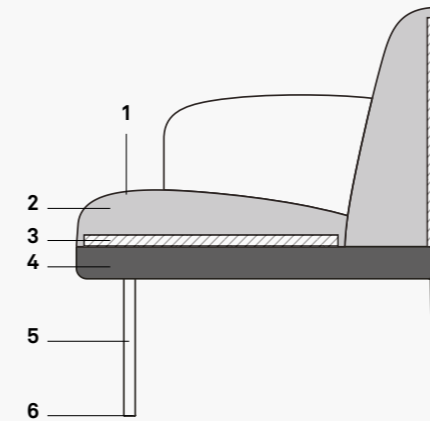

1. Upholstery

Rivestimento
Revêtement

2. High resistance foam

Poliuretano espanso indeformabile
Mousse haute densité

3. Wooden inner frame

Struttura interna in legno
Structure interne en bois

4. Solid oakwood frame edge

Struttura esterna in rovere massello
Structure extérieure en chêne massif

5. Steel tube legs

Gambe in tubo d'acciaio
Pieds en tube d'acier

6. Felt pad

Feltrino
Freutre

Internal structure in multilayer wood, polyurethane foam padding; external structure in solid oakwood and frame with 4 varnished steel legs.

Struttura interna in multistrato, imbottitura in poliuretano espanso; struttura esterna in rovere massello e telaio con 4 gambe in acciaio verniciato.

Structure interne en contreplaqué, rembourrage en mousse polyuréthane; structure extérieure en chêne massif et structure à 4 pieds en acier peint.

COFFEE TABLE VARIANTS

VARIANTI TAVOLINO - VARIANTES DE TABLE BASSE

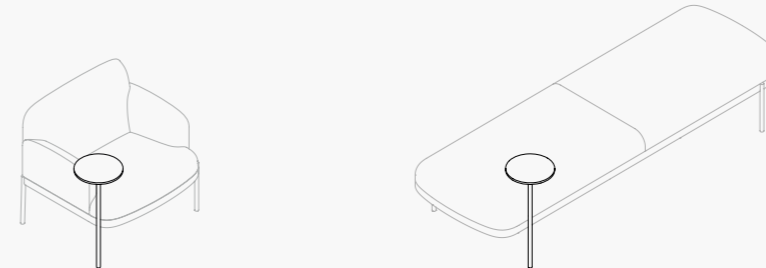

Available for the two front legs

Disponibile per le due gambe anteriori
Disponible pour les deux pieds avant

Available for all legs

Disponibile per tutte le gambe
Disponible pour tout le pieds

AB 1000
armchair
poltrona
fauteuil

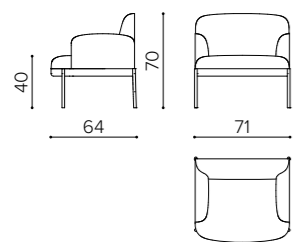

m 2,15 ☆ mq 4 📦 kg 18,5 🛠 mc 0,3

AB 2000
2 seater sofa
divano 2 posti
canapé 2 places

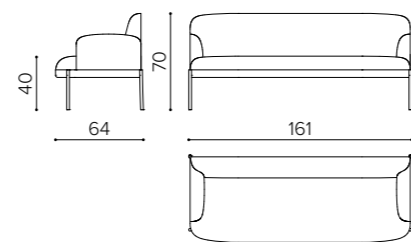

m 3,6 ☆ mq 6,6 📦 kg 36 🛠 mc 0,7

AB PSB2
USB 5V A+C, 2 mt. of cable, power socket
USB 5V A+C, 2 mt. di cavo, presa corrente
USB 5V A+C, 2 mt. de câble, prise de courant

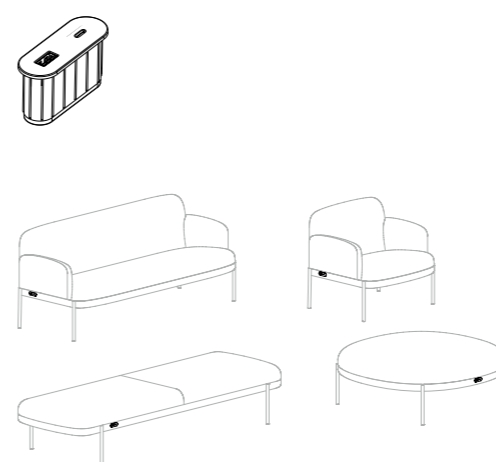

AB T25FS
coffee table
tavolino
table basse

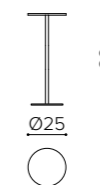

📦 kg 0,6 🛠 mc 0,05

AB 5P0R
pouf
pouf
pouf

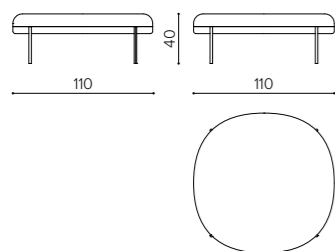

m 2,4 ☆ mq 4 📦 kg 20 🛠 mc 0,4

AB 3P00
bench
panca
banc

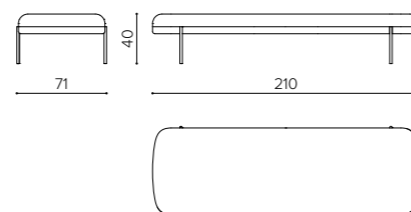

m 2,4 ☆ mq 4 📦 kg 30 🛠 mc 0,59

AB T25R
coffee table
tavolino
table basse

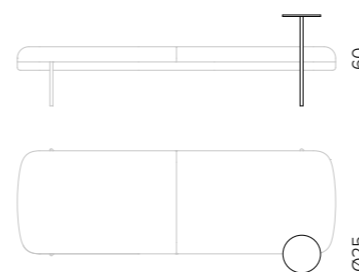

📦 kg 0,2 🛠 mc 0,05

AB CXT25
central coffee table
tavolino centrale
table basse centrale

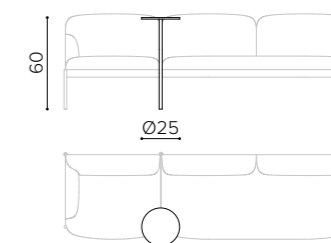

📦 kg 0,2 🛠 mc 0,05

AB 1L00
left armchair
poltrona sinistra
fauteuil gauche

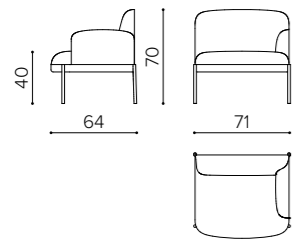

m 1,65 ☆ mq 3,2 📦 kg 17,5 🛠 mc 0,3

AB 1R00
right chair
poltrona destra
fauteuil droit

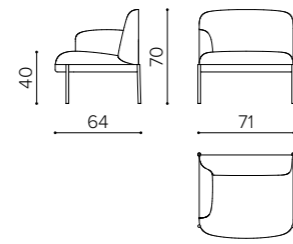

AB 1C00
central armchair
poltrona centrale
fauteuil central

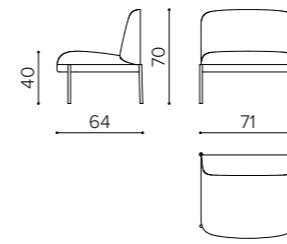

m 1,8 ☆ mq 4 📦 kg 16,5 🛠 mc 0,3

AB L140
left sofa
divano sinistro
canapé gauche

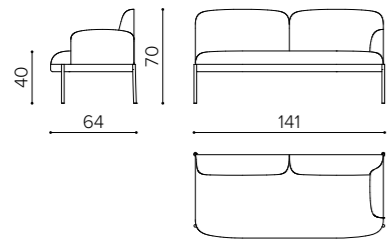

m 5 ☆ mq 10 📦 kg 30 🛠 mc 0,63

AB R140
right sofa
divano destro
canapé droit

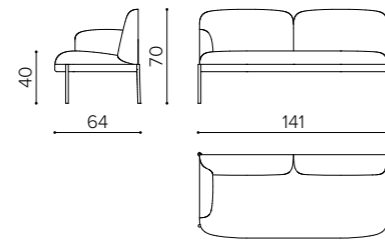

AB C140
central sofa
divano centrale
canapé central

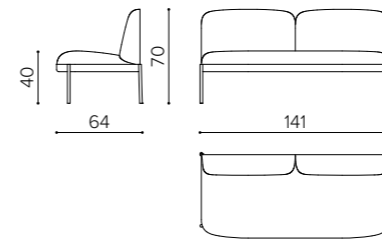

m 4,6 ☆ mq 9 📦 kg 29 🛠 mc 0,63

AB L160
left sofa
divano sinistro
canapé gauche

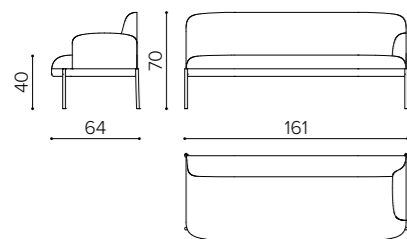

m 4,4 ☆ mq 9 📦 kg 35 🛠 mc 0,7

AB R160
right sofa
divano destro
canapé droit

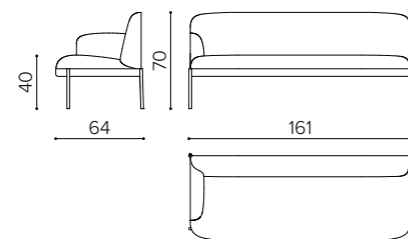

AB C160
central sofa
divano centrale
canapé central

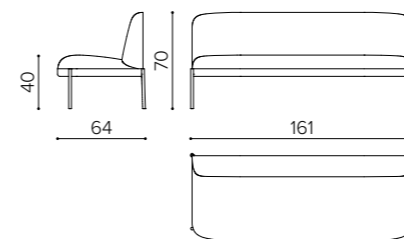

m 4 ☆ mq 8 📦 kg 34 🛠 mc 0,7

AB 90CV
central sofa
divano centrale
canapé central

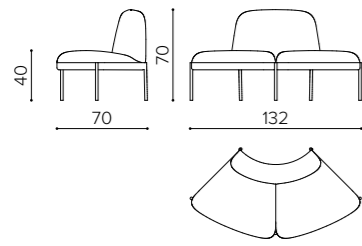

m 1,65 ☆ mq 3,2 ✎ mc 0,64

AB 45CV
central sofa
divano centrale
canapé central

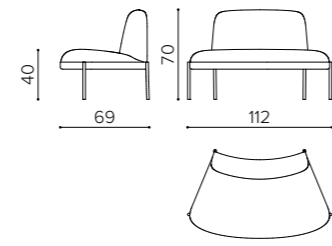

m 1,65 ☆ mq 3,2 ✎ mc 0,54

AB 90CX
central sofa
divano centrale
canapé central

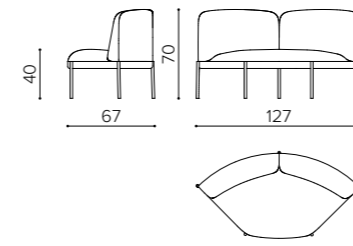

m 1,65 ☆ mq 3,2 ✎ mc 0,59

AB 45CX
central sofa
divano centrale
canapé central

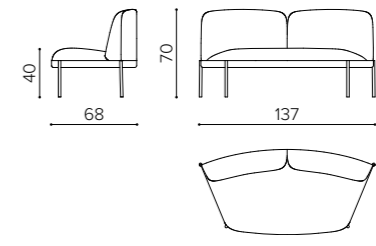

m 1,65 ☆ mq 3,2 ✎ mc 0,65

AB 90CVR/L
terminal sofa
divano terminale
canapé terminal

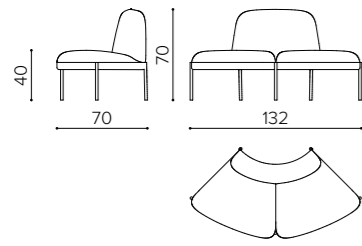

m 5 ☆ mq 10 ✎ mc 0,63

AB 45CVR/L
terminal sofa
divano terminale
canapé terminal

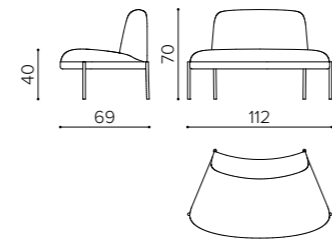

m 5 ☆ mq 10 ✎ mc 0,54

AB 90CXR/L
terminal sofa
divano terminale
canapé terminal

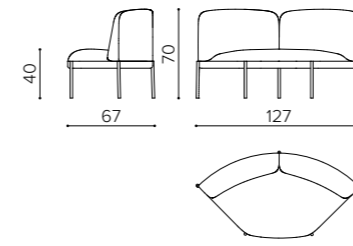

m 5 ☆ mq 10 ✎ mc 0,59

AB 45CXR/L
terminal sofa
divano terminale
canapé terminal

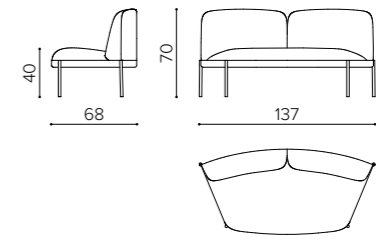

m 5 ☆ mq 10 ✎ mc 0,65

AB TCXO
coffee table
tavolino
table basse

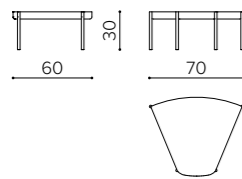

m 4,4 ☆ mq 9 ✎ mc 0,12

AB TCVO
coffee table
tavolino
table basse

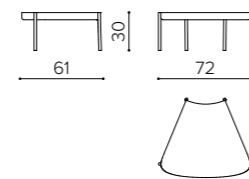

m 4,4 ☆ mq 9 ✎ mc 0,13

AB TCSO
coffee table
tavolino
table basse

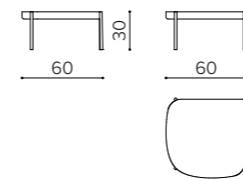

m 4,4 ☆ mq 9 ✎ mc 0,1

AB TCCO
coffee table
tavolino
table basse

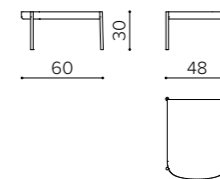

m 4,4 ☆ mq 9 ✎ mc 0,08

CONFIGURATION EXAMPLE 1

ESEMPIO COMPOSIZIONE 1 - EXEMPLE CONFIGURATION 1

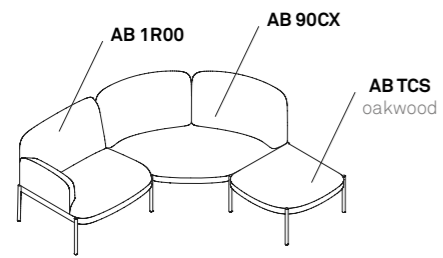

216 W x 115 D x 70 H

CONFIGURATION EXAMPLE 2

ESEMPIO COMPOSIZIONE 2 - EXEMPLE CONFIGURATION 2

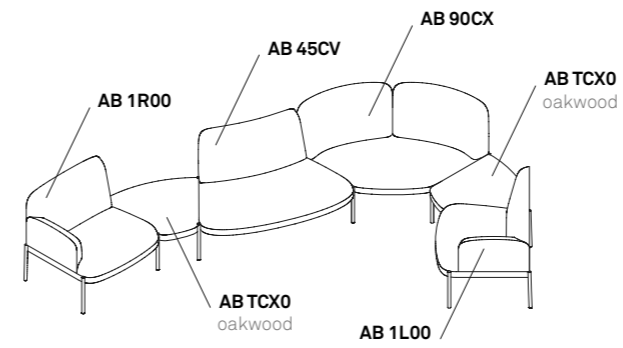

340 W x 187 D x 70 H

CONFIGURATION EXAMPLE 3

ESEMPIO COMPOSIZIONE 3 - EXEMPLE CONFIGURATION 3

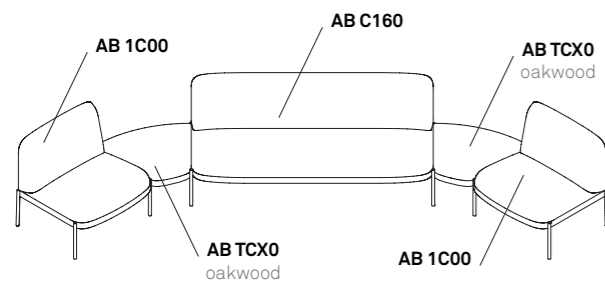

388 W x 115 D x 70 H

CONFIGURATION EXAMPLE 4

ESEMPIO COMPOSIZIONE 4 - EXEMPLE CONFIGURATION 4

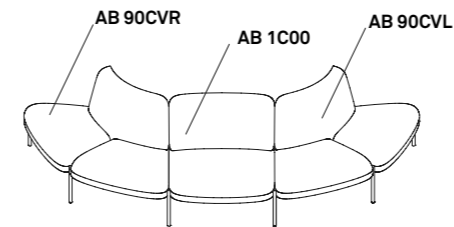

261 W x 100 D x 70 H

CONFIGURATION EXAMPLE 5

ESEMPIO COMPOSIZIONE 5 - EXEMPLE CONFIGURATION 5

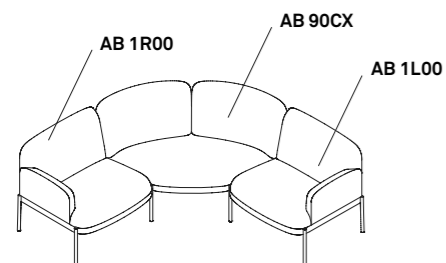

226 W x 115 D x 70 H

CONFIGURATION EXAMPLE 6

ESEMPIO COMPOSIZIONE 6 - EXEMPLE CONFIGURATION 6

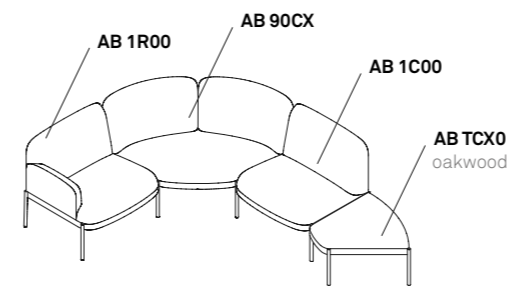

253 W x 140 D x 70 H

CONFIGURATION EXAMPLE 7

ESEMPIO COMPOSIZIONE 7 - EXEMPLE CONFIGURATION 7

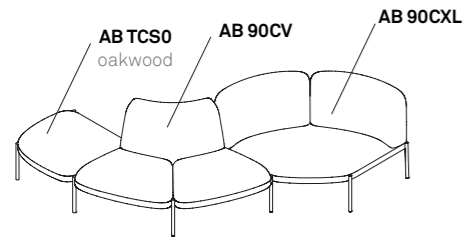

257 W x 105 D x 70 H

CONFIGURATION EXAMPLE 8

ESEMPIO COMPOSIZIONE 8 - EXEMPLE CONFIGURATION 8

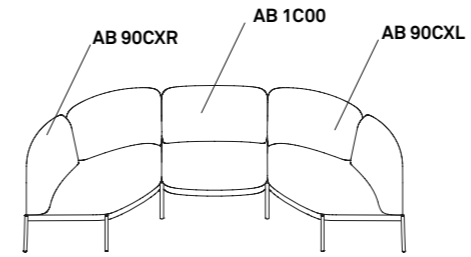

350 W x 90 D x 70 H

CONFIGURATION EXAMPLE 9

ESEMPIO COMPOSIZIONE 9 - EXEMPLE CONFIGURATION 9

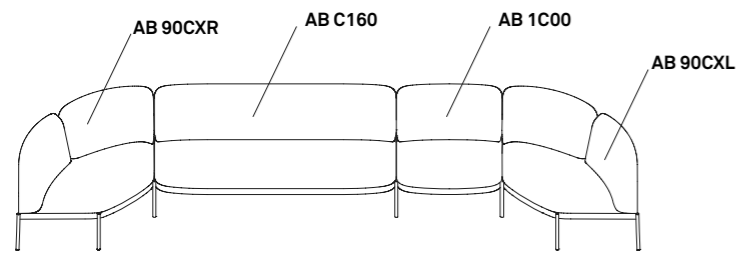

410 W x 90 D x 70 H

CONFIGURATION EXAMPLE 10

ESEMPIO COMPOSIZIONE 10 - EXEMPLE CONFIGURATION 10

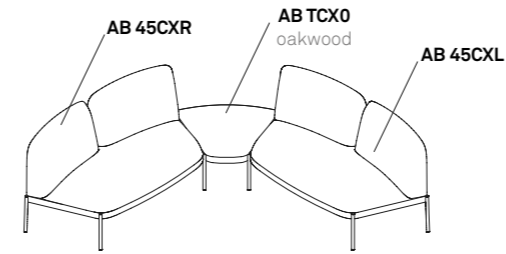

265 W x 125 D x 70 H

CONFIGURATION EXAMPLE 11

ESEMPIO COMPOSIZIONE 11 - EXEMPLE CONFIGURATION 11

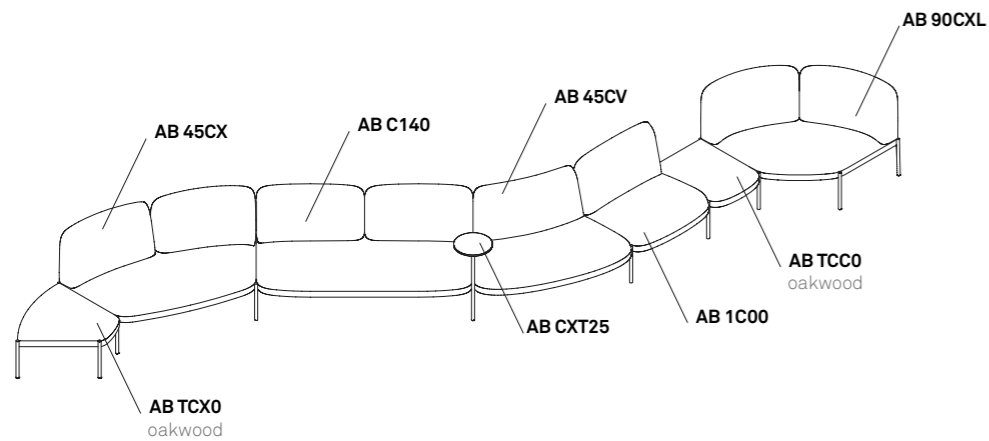

560 W x 270 D x 70 H

CONFIGURATION EXAMPLE 12

ESEMPIO COMPOSIZIONE 12 - EXEMPLE CONFIGURATION 12

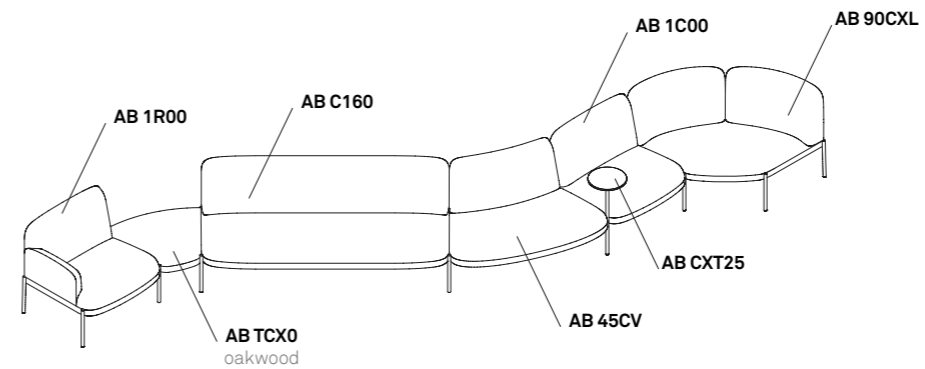

258 W x 472 D x 70 H

UPHOLSTERY CATEGORIES

CATEGORIE RIVESTIMENTI - CATÉGORIES DE TISSUS D'AMEUBLEMENT

S	camira	GRAVITY	76% Polyester, 24% Recycled Polyester, non metallic dyestuffs 76% Poliestere, 24% Poliestere riciclato, coloranti non metallici 76% Polyester, 24% Polyester recyclé, colorants non métalliques
	FIDIVI	LASER N	100% Polyester Trevira CS 100% Poliestere Trevira CS - 100% Polyester Trevira CS
	FIDIVI	ONE	100% Recycled polyester 100% Poliestere riciclato - 100% Polyester recyclé
T	FIDIVI	MAYA	100% Polyester Trevira CS 100% Poliestere Trevira CS - 100% Polyester Trevira CS
	FIDIVI	INCAS	100% Polyester Trevira CS 100% Poliestere Trevira CS - 100% Polyester Trevira CS
	FIDIVI	LASER J & J FLASH	100% Polyester Trevira CS 100% Poliestere Trevira CS - 100% Polyester Trevira CS
M	kvadrat	FIELD 2	100% Polyester Trevira CS 100% Poliestere Trevira CS - 100% Polyester Trevira CS
	FIDIVI	CORTE	100% Polyester Trevira CS 100% Poliestere Trevira CS - 100% Polyester Trevira CS
	camira	MAIN LINE FLAX	70% Virgin Wool, 30% Flax 70% Lana Vergine, 30% Lino - 70% Laine vierge, 30% Lin
	SPRADLING®	VALENCIA	Vinyl / Urethane Topcoat Finitura in vinile / uretano - Revêtement de finition vinyle / uréthane
F	camira	SYNERGY	95% Virgin Wool, 5% Polyamide 95% Lana Vergine, 5% Poliammide - 95% Laine vierge, 5% Polyamide
	kvadrat	REMIX 3	90% New wool (worsted), 10% Nylon 90% Lana vergine (pettinata), 10% Nylon - 90% Laine vierge (peignée), 10% Nylon
	Gabriel	FOCUS	100% New Zealand wool 100% lana della Nuova Zelanda - 100% laine de Nouvelle-Zélande
	Gabriel	FOCUS MELANGE	100% New Zealand wool 100% lana della Nuova Zelanda - 100% laine de Nouvelle-Zélande
L	kvadrat	MEMORY 2	100% Polyester Trevira CS 100% Poliestere Trevira CS - 100% Polyester Trevira CS
	kvadrat	COLLINE 2	75% New wool (worsted), 17% Acrylic, 8% Nylon 75% Lana vergine (pettinata), 17% Acrilico, 8% Nylon 75% Laine vierge (peignée), 17% Acrilico, 8% Nylon
P	maharam	MERIT	76% Recycled polyester, 24% Polyester 76% Poliestere riciclato, 24% Poliestere - 76% Polyester recyclé, 24% Polyester
	DANI	PANAMA GENUINE LEATHER	Chrome tanned european bovine raw hides Pelle bovina europea ai sali di cromo - Cuir de bovin européenne avec sels de chrome
PX	FEBRIK	UNIFORM MELANGE	European bovine leather, full grain Pelle pieno fiore, bovina europea - Cuir de bovin européen, pleine fleur
	kvadrat elmo	BALTIQUE FULL GRAIN LEATHER	European bovine leather Pelle bovina europea - Cuir de bovin européen

OUTDOOR UPHOLSTERY CATEGORIES

CATEGORIE RIVESTIMENTI OUTDOOR - CATÉGORIES DE TISSUS D'AMEUBLEMENT OUTDOOR

M	SPRADLING®	MAGLIA	Vinyl / Urethane Topcoat Finitura in vinile / uretano - Revêtement de finition vinyle / uréthane
F	RUBELLI	FIFTYSHADES	100% PL flame retardant 100% PL ignifugo - 100% PL ignifuge
L	RUBELLI	DIECIELODE	100% PL flame retardant 100% PL ignifugo - 100% PL ignifuge
		FABTHIRTY	100% PL flame retardant 100% PL ignifugo - 100% PL ignifuge

OUTDOOR USE AND MAINTENANCE

USO E MANUTENZIONE PER L'OUTDOOR - UTILISATION ET MAINTENANCE POUR L'EXTÉRIUR



STEEL
METALLO/MÉTAL

Steel is used in the manufacture of metal products. This material galvanised and powder-coated, is ideal for outdoor use. Regarding products intended for seaside locations we recommend cleaning on a quarterly basis, with a cloth using water or mild detergents. During the winter period we recommend storing the furniture in closed, dry rooms in order to prevent condensation. In fact, although our products are suitable for outdoor use, during colder months the products should be stored in a closed, dry place in order to prevent moisture and seasonal frosts from affecting the finish.

Nella realizzazione dei prodotti metallici viene impiegato l'acciaio, il quale in seguito al processo di zincatura e di verniciatura a polveri, risulta ideale per l'utilizzo outdoor. Durante il periodo invernale consigliamo di conservare gli arredi in luoghi chiusi ed asciutti per evitare la formazione di condensa. Per i prodotti destinati a località marittime consigliamo con cadenza trimestrale una pulizia con un panno utilizzando acqua o detersivi non aggressivi. Nonostante i nostri prodotti siano adatti all'ambiente esterno, durante il periodo invernale è consigliato il ricovero dei prodotti in un luogo chiuso ed asciutto. In modo da evitare che l'umidità unita alle gelate stagionali possa in qualche modo intaccare le finiture.

L'acier est la matière première utilisée dans la fabrication de ces produits métalliques qui, après un processus de galvanisation et un revêtement de finition par poudre, sont idéaux pour une utilisation en extérieur. Pour les produits destinés à être utilisés en bord de mer, nous recommandons un nettoyage trimestriel avec un chiffon utilisant de l'eau ou des détergents doux. Bien que nos produits soient adaptés à un usage extérieur, nous recommandons de les stocker dans un endroit fermé et sec pendant l'hiver; ceci afin d'éviter que l'humidité combinée aux gelées saisonnières n'affecte d'une manière ou d'une autre les finitions.



STONE
PIETRA/PIERRE

The stone tops are made of Marble or Quarella and they are ideal for the outdoor environment. Use a soft cloth with just water for daily cleaning. Avoid the use of aggressive abrasive sponges or steel wool pads. The furnishings made of stone such as marble and Quarella, during the first week of use will undergo a slight dulling due to contact with external elements. This is a natural phenomenon which does not affect the quality of the material. When the furniture is placed in seaside locations or swimming pools, cleaning with fresh water on a quarterly basis is recommended in order to avoid water corrosion due to salt build-up or chlorosis. Although our products are suitable for outdoor use, during colder months the products should be stored in a closed, dry place in order to prevent moisture and seasonal frosts from affecting the finish.

Materiale composito autoportante adatto all'ambiente Outdoor. Utilizzare un panno morbido con sola acqua per la pulizia quotidiana. In caso di necessità utilizzare detersivi non aggressivi. Evitare l'impiego di spugne abrasive o pagliette in acciaio. Nel caso di collocamento degli arredi in località marittime o piscine, si consiglia una pulizia trimestrale utilizzando acqua dolce per evitare principi di corrosione dovuti ad accumuli salini o clorosi. Nonostante i nostri prodotti siano adatti all'ambiente esterno, durante il periodo invernale è consigliato il ricovero dei prodotti in un luogo chiuso ed asciutto. In modo da evitare che l'umidità unita alle gelate stagionali possa in qualche modo intaccare le finiture.

Les dessus en pierre sont en marbre ou en quarella, idéaux pour une utilisation en extérieur. Utilisez un chiffon doux avec de l'eau uniquement pour le nettoyage quotidien. Évitez d'utiliser des détergents agressifs, des éponges abrasives ou des tampons de laine d'acier. Les meubles en pierre tels que le marbre et la Quarella, pendant la première semaine, subissent un léger ternissement dû au contact avec les éléments extérieurs. Il s'agit d'un phénomène naturel, qui n'affecte pas la qualité du matériau. Si le meuble est placé dans des stations balnéaires ou des piscines, nous recommandons un nettoyage trimestriel à l'eau douce pour éviter la corrosion due à l'accumulation de sel ou à la chlorose. Bien que nos produits conviennent à une utilisation en extérieur, il est recommandé, pendant la période hivernale, de stocker les produits dans un endroit fermé et sec, afin d'éviter que l'humidité combinée aux gelées saisonnières n'affecte d'une manière ou d'une autre la finition.



FABRICS
TESSUTI/TISSU

The fabrics used are naturally resistant to climatic elements, UV-resistant and anti-microbial. After heavy rainfall it is recommended to remove the cushions for quick drying and in order to prevent condensation. When the furniture is placed in seaside locations or swimming pools, cleaning with fresh water on a quarterly basis is recommended in order to avoid water corrosion due to salt build-up or chlorosis. Although our products are suitable for outdoor use, during colder months the products should be stored in a closed, dry place in order to prevent moisture and seasonal frosts from affecting the finish.

I tessuti impiegati sono naturalmente resistenti agli elementi climatici, resistenti ai raggi UV ed anti-microbici. A seguito di forti precipitazioni è consigliato rimuovere i cuscini per un'asciugatura rapida e prevenire la formazione di condensa. Nel caso di collocamento degli arredi in località marittime o piscine, si consiglia una pulizia trimestrale utilizzando acqua dolce per evitare principi di corrosione dovuti ad accumuli salini o clorosi. Nonostante i nostri prodotti siano adatti all'ambiente esterno, durante il periodo invernale è consigliato il ricovero dei prodotti in un luogo chiuso ed asciutto. In modo da evitare che l'umidità unita alle gelate stagionali possa in qualche modo intaccare le finiture.

Les tissus utilisés sont naturellement résistants aux éléments climatiques, résistants aux UV et antimicrobiens. Après de fortes pluies, il est toutefois conseillé de retirer les coussins pour un séchage rapide et pour éviter la formation de condensation. Si le mobilier est placé dans des stations balnéaires ou des piscines, nous recommandons un nettoyage trimestriel à l'eau douce pour éviter la corrosion due à l'accumulation de sel ou de chlore. Bien que nos produits soient adaptés à une utilisation en extérieur, il est recommandé de les stocker dans un endroit fermé et sec pendant la période hivernale, afin d'éviter que l'humidité combinée aux gelées saisonnières n'affecte d'une manière ou d'une autre les finitions.

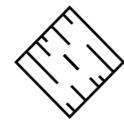

HPL
HPL/HPL

Self-supporting composite material suitable for outdoor environment. Use a soft cloth with water only for daily cleaning. If necessary, use non-aggressive detergents. Please avoid using abrasive sponges or steel wool pads. When the furniture is placed in seaside locations or swimming pools, cleaning with fresh water on a quarterly basis is recommended in order to avoid water corrosion due to salt build-up or chlorosis. Although our products are suitable for outdoor use, during colder months the products should be stored in a closed, dry place in order to prevent moisture and seasonal frosts from affecting the finish.

Materiale composito autoportante adatto all'ambiente Outdoor. Utilizzare un panno morbido con sola acqua per la pulizia quotidiana. In caso di necessità utilizzare detersivi non aggressivi. Evitare l'impiego di spugne abrasive o pagliette in acciaio. Nel caso di collocamento degli arredi in località marittime o piscine, si consiglia una pulizia trimestrale utilizzando acqua dolce per evitare principi di corrosione dovuti ad accumuli salini o clorosi. Nonostante i nostri prodotti siano adatti all'ambiente esterno, durante il periodo invernale è consigliato il ricovero dei prodotti in un luogo chiuso ed asciutto. In modo da evitare che l'umidità unita alle gelate stagionali possa in qualche modo intaccare le finiture.

Matériau composite autoportant adapté à un usage extérieur. Utilisez un chiffon doux avec de l'eau uniquement pour le nettoyage quotidien. Si nécessaire, utilisez des détergents non agressifs. Évitez d'utiliser des éponges abrasives ou des tampons de laine d'acier. Si le mobilier doit être installé dans des stations balnéaires ou des piscines, nous recommandons un nettoyage trimestriel à l'eau douce pour éviter la corrosion due au sel ou au chlore. Bien que nos produits conviennent à une utilisation en extérieur, il est recommandé, pendant la période hivernale, de stocker les produits dans un endroit fermé et sec, afin d'éviter que l'humidité combinée aux gelées saisonnières n'affecte d'une manière ou d'une autre les finitions.

STANDARD STEEL RAL COLORS

COLORI RAL STANDARD PER ACCIAIO - COULEURS RAL STANDARD POUR L'ACIER

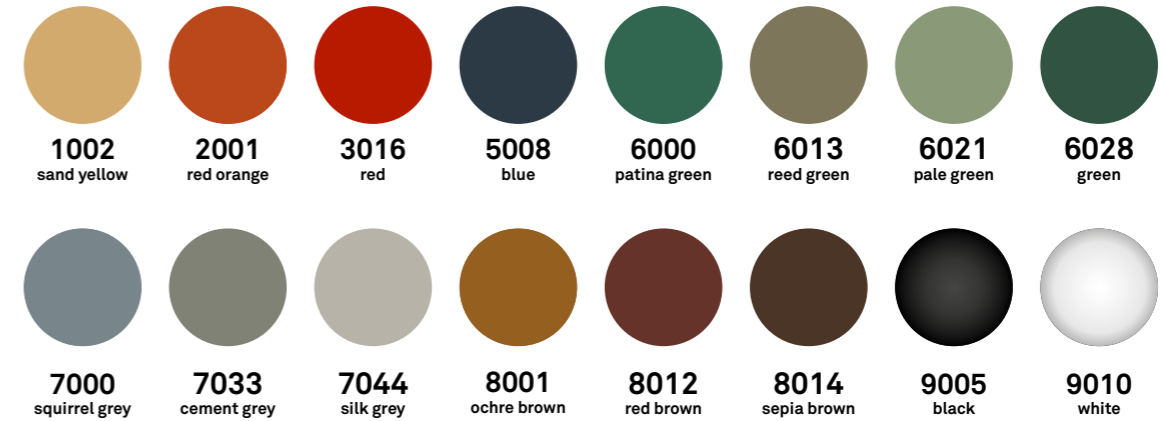

The standard finishings for the steel elements are the RAL shown. Customized RAL colors finishings are available upon request.

Le finiture standard degli elementi in acciaio sono i RAL mostrati. Su richiesta sono disponibili colorazioni customizzate su altre tinte RAL.

Les finitions standard des éléments en acier sont le RAL illustré. Des couleurs RAL personnalisées sont disponibles sur demande.



COLOR SWATCHES AND TECH INFO

CAMPIONI COLORI E INFO TECNICHE - ÉCHANTILLONS DE COULEURS ET INFOS TECHNIQUES

DOWNLOAD

Click on the image above to download the color swatches and technical informations

Clicca sull'immagine per scaricare il pdf dei campioni colori e specifiche tecniche

Cliquez sur l'image ci-dessus pour télécharger les échantillons de couleurs et les informations techniques

