

SNOWSOUND

Snowcurtains

CUSTOM MADE ACOUSTIC CURTAINS

Caimi

Index

02 COMPANY PROFILE

06 RESEARCH & TECHNOLOGY

16 ACOUSTIC SERVICES AND CONFIGURATOR

22 TECHNICAL SHEETS

34 INSPIRATIONS

60 TEXTILE FINISHES

Caimi Brevetti

MADE IN ITALY SINCE 1949

I_Fondata nel 1949, Caimi è una delle principali realtà produttive europee design oriented nel settore dell'arredamento, dei complementi d'arredo e delle soluzioni acustiche per l'ufficio, la casa e il contract. Da **oltre 70 anni** Caimi continua a ricercare e sperimentare nuove soluzioni per migliorare concretamente la vita delle persone e gli ambienti in cui vivono. Grazie a una sofisticata integrazione fra struttura produttiva e logistica, gestisce con successo una gamma di prodotti composta da oltre **3.000** articoli e **35.000** componenti, garantendo alla propria clientela tempi di consegna estremamente rapidi.

EN_Founded in 1949, Caimi is one of the leading European design-oriented manufacturers of furniture and complements for the office, home and contract sectors. For **over 70 years** Caimi has continued to research and assay new solutions for the betterment of people's lives and living spaces. Thanks to its sophisticated integration of production line work and logistics operations, Caimi can effect extremely fast deliveries of any orders from its product range, which is made up of around **3.000** items and more than **35.000** separate components.

>> Acoustic
& design
solutions

>> Over 60 international awards

I_L'elenco completo dei premi è disponibile sul sito www.caimi.com

EN_The full list of prizes and awards is available at www.caimi.com



2022



2016



2008



2022



2011



GERMAN DESIGN AWARD WINNER

2018



GERMAN DESIGN AWARD WINNER

2016



GERMAN DESIGN AWARD WINNER

2016



SUSTAINABILITY

I_Caimi, da sempre sensibile nei confronti delle tematiche ambientali e dell'ecosostenibilità, utilizza, dove tecnicamente possibile, materiali riciclabili o riutilizzabili. La produzione è composta in prevalenza da oggetti monomaterici, facilmente riciclabili: gli oggetti composti da più materiali sono in larga parte pensati per essere disassemblabili, consentendo di riciclare separatamente i singoli componenti.

EN_Caimi has always had an attentive eye for environmental issues and ecosustainability. This is why, if technically feasible, we use recyclable or reusable materials. Production consists mainly of single-material, easily recyclable objects: objects made of multiple materials are in most cases designed to be disassembled. This allows separate recycling of the individual components.

Scopri la nostra sostenibilità



IT

Discover our sustainability



EN



Research & Technology



Caimi Open lab

RESEARCH, ACADEMY & NO PROFIT

I_Caimi Open Lab è uno spazio all'avanguardia che vanta 7 laboratori avveniristici dedicati alla ricerca teorica e applicata in ambito tecnologico, acustico e fisico. Un centro di ricerca volto a sperimentare il comportamento del suono, le capacità percettive dell'uomo e gli effetti che il suono ha sull'essere umano.

EN_Caimi Open Lab is an advanced facility housing 7 futuristic laboratories dedicated to theoretical and applied research in technology, acoustics and physics. The purpose of the research facility is to carry out experiments on the behaviour of sound, on the perceptive capacities of humans, and on the effects of sound on people.

Scopri
Caimi Open Lab



IT

Discover
Caimi Open Lab



EN

SNOWSOUND

>> Where design
and research
meet



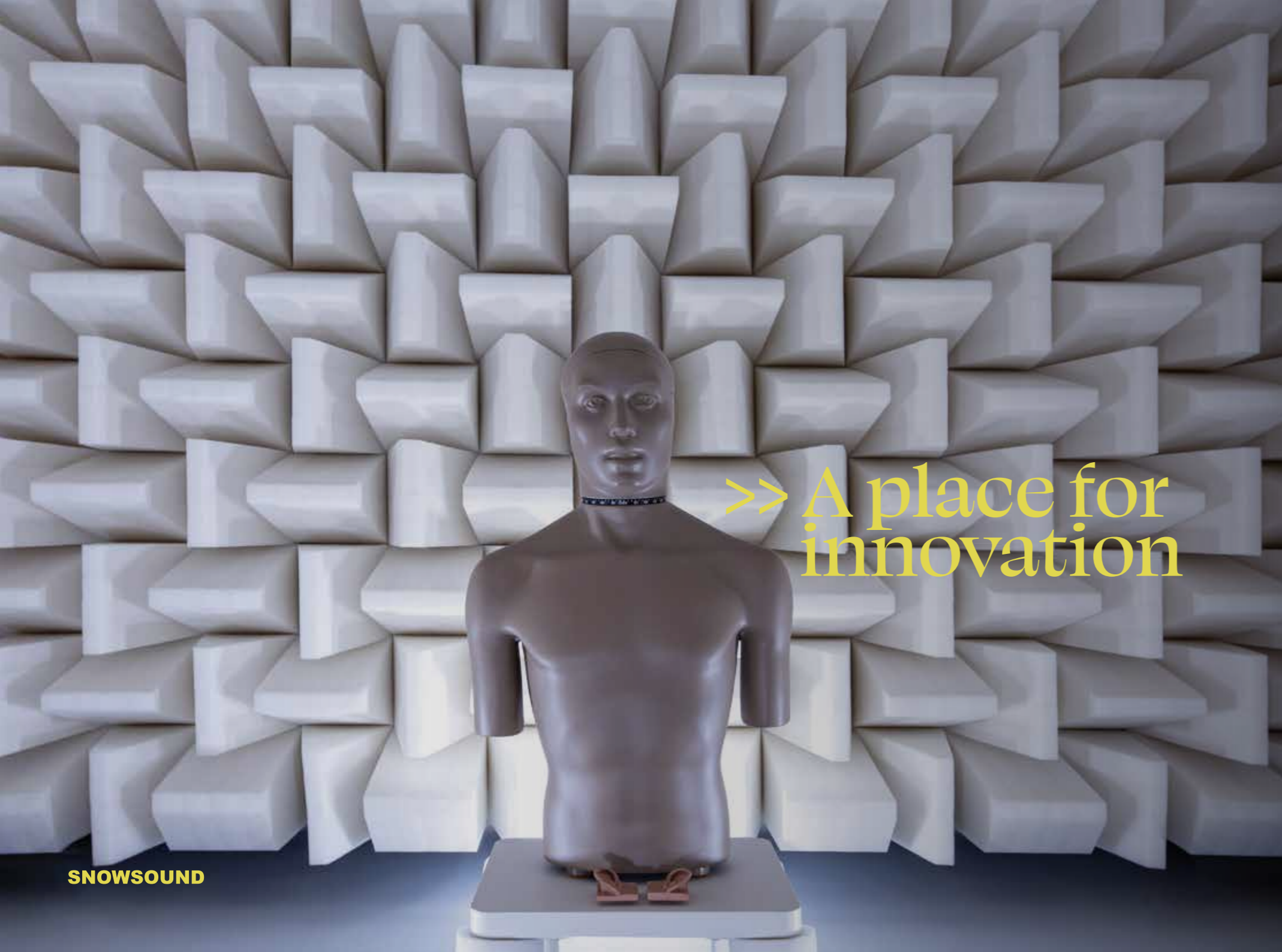

SNOWSOUND

Caimi Open Lab:
ACADEMY & NO-PROFIT

I_Open Lab è anche una struttura no profit gratuitamente messa al servizio di Università, Istituti di Ricerca, Fondazioni ed Enti. Open Lab, un grande laboratorio aperto al mondo, perché non esiste innovazione senza ricerca.



EN_Open Lab also operates as a not-for-profit entity that is placed free of charge at the disposition of universities, research institutes, foundations and public-sector bodies. Open Lab: A laboratory complex whose doors are open to the world; without research, there can be no innovation.

Snowsound Fiber

ACOUSTIC TEXTILES (PATENTED)

I La tecnologia brevettata Snowsound Fiber è basata su morbide fibre acustiche di poliestere intrinsecamente ignifughe e interconnesse tra loro. L'interazione tra le fibre di Snowsound Fiber e l'aria permette di controllare il riverbero regolando con precisione la risposta acustica dell'ambiente in base alle modalità di posa, alla superficie e alla distanza tra le fibre e la parete, consentendo di ridurre il fastidioso riverbero acustico negli ambienti, migliorando la qualità della vita e del lavoro.

EN The patented Snowsound Fiber technology is based on soft interwoven polyester acoustic fibers that are inherently fire-resistant. The interaction between Snowsound Fiber and air allows controlling reverberation while adjusting the environment's acoustics with precision taking advantage of installation modes, product's surface and distance from the wall. This reduces the annoying acoustic reverberation improving quality both of life and of work.

Ascolta la differenza
senza/con le nostre tende



IT

Experience the difference
without/with our curtains



EN

SNOWSOUND

>> A patented technology
hidden in fabrics



>> Where science meets design

SNOWSOUND

I_I materiali Snowsound Fiber sono stati testati secondo la norma UNI EN ISO 354. I grafici in funzione dell'applicazione sono disponibili nel sito www.caimi.com. La scelta dei diversi tipi di materiale Snowsound Fiber e la modalità di installazione, consentono di poter privilegiare l'assorbimento di specifiche frequenze (basse, medie o alte) o di assorbire diverse frequenze in modo uniforme. Il comportamento di Snowsound Fiber, in base al materiale e alle modalità di installazione, varia in termini di classe di assorbimento che può raggiungere la **classe A**.

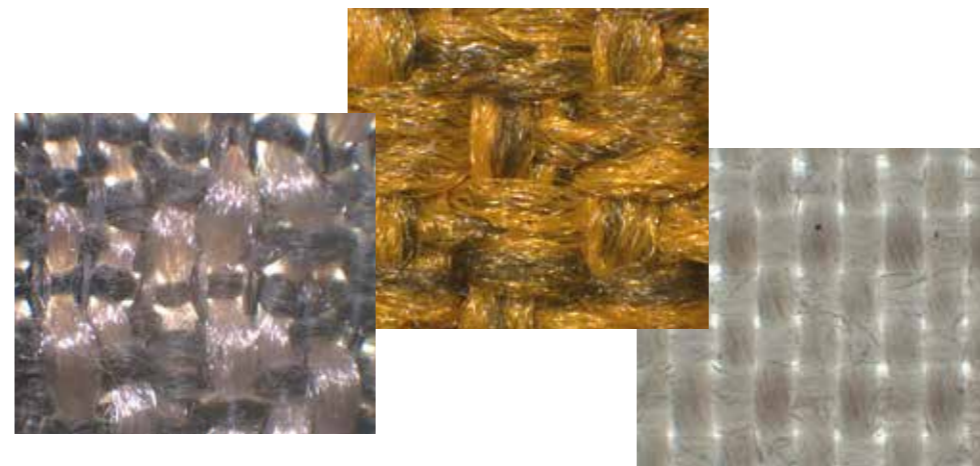

EN_Snowsound Fiber materials have been tested according to UNI EN ISO 354. The graphs for each application can be found on our website www.caimi.com. The choice of different Snowsound Fiber materials and the installation modes allow a selective absorption at precise ranges (low, medium, high) or a more uniform absorption at all frequencies. Snowsound Fiber's behavior varies based on the selected material and the installation mode and can reach **A class** for sound absorption.



Acoustic services & configurator



Snowsound Software

ACOUSTIC PROJECT WITH SNOWSOUND

I_Caimi ha sviluppato **due software di calcolo** che mette liberamente a disposizione dei clienti per progettare l'acustica in ambienti nuovi o esistenti. La precisione dei software Snowsound è comprovata dagli oltre **100.000 calcoli acustici** effettuati nel corso degli anni, da **2 premi internazionali** ricevuti e dal nuovo laboratorio di ricerca **Open Lab** che permette di sviluppare ricerca sempre più avanzata.

EN_Caimi developed **two acoustic design softwares** that are offered to customers completely free of charge, applicable to both new or existing environments. The precision of the software is proven by more than **100,000 acoustic calculations** made over the years, by the **2 international awards** received and by the new research laboratory **Open Lab** that allows to develop increasingly advanced research.

Scopri i nostri software



IT

Discover our software



EN

SNOWSOUND

>> Measuring your acoustic comfort

Acoustic Analysis

Software Release 2.2

Pre-intervention acoustic environment



>> Quick and
easy way

Snowcurtains Software

CALCULATE CURTAINS IN A COUPLE OF CLICKS

I_Il software di configurazione consente, in modo semplice e rapido, di codificare e preventivare le tende acustiche Snowcurtains realizzate su misura.

EN_The configuration software allows you to quickly and easily code and quote custom-made Snowcurtains.

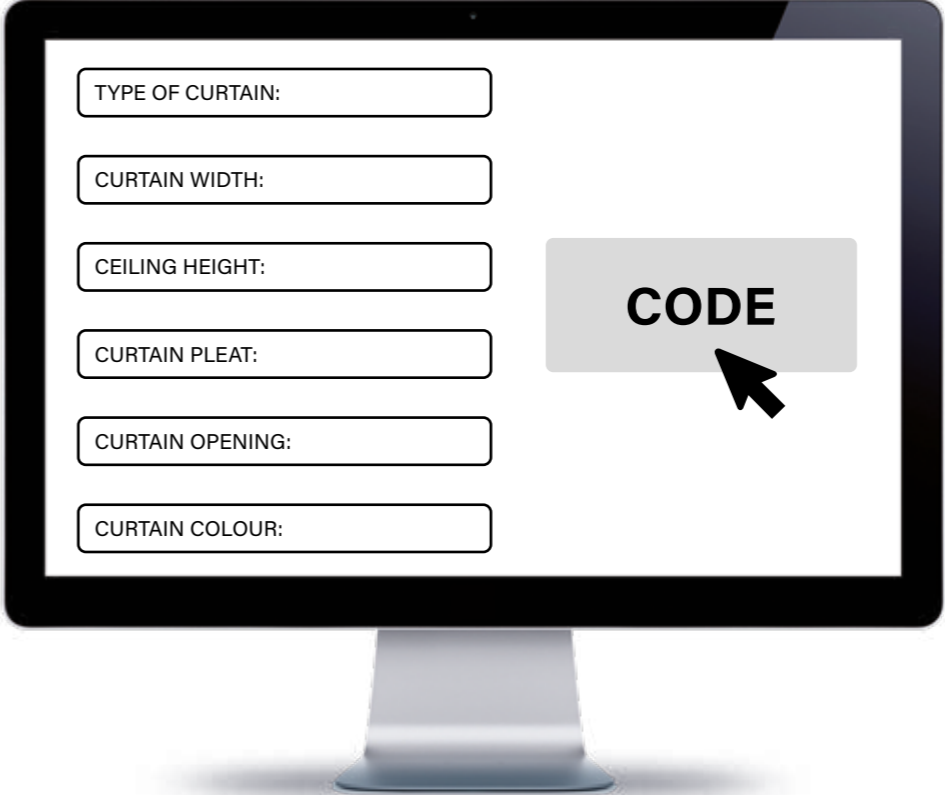

Technical sheets



SNOWSOUND

Roller shades

I_Tende a rullo con comando a catenella, realizzate in tessuto acustico Snowsound Fiber 2R. Il sistema è realizzato in alluminio, acciaio e tecnopolimero e può essere fissato direttamente a parete/soffitto.

EN_Roller shades with chain movement, made of Snowsound Fiber 2R acoustic fabric. The system is made of aluminium, steel and high-tech polymer. It can be fixed directly to the wall/ceiling.

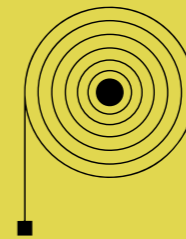

Roller shades:

WALL/CEILING

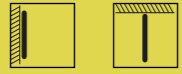

SISTEMA TENDA ROLLER SHADES SYSTEM

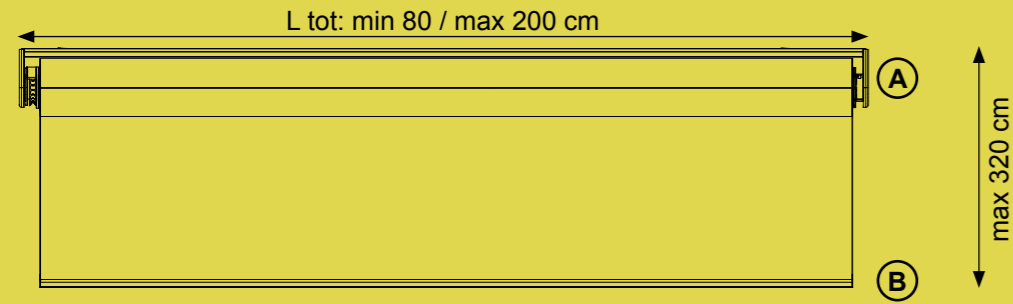

FINITURE STRUTTURA, SUPPORTI E BALZA FINISHES FOR STRUCTURE, SUPPORTS AND PROFILE



APPLICAZIONE A PARETE WALL FIXING

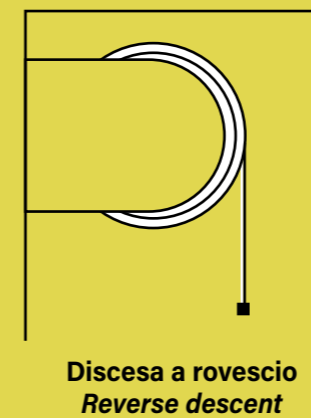
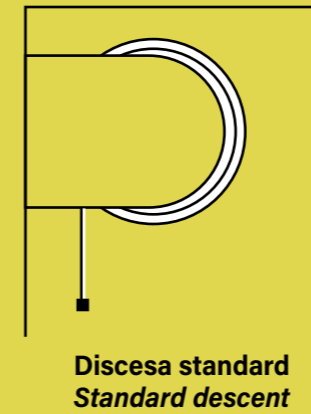

APPLICAZIONE A SOFFITTO CEILING FIXING

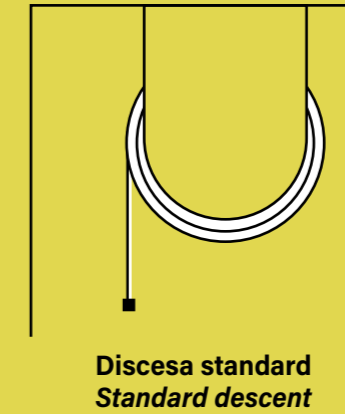

APPLICAZIONE IN NICCHIA NICHE FIXING



FISSAGGIO FIXING

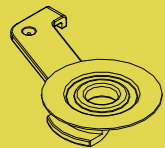

SUPPORTO SUPPORT (A)

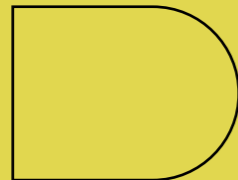

BALZA PROFILE (B)



"CHILD SAFETY" (included)





SNOWSOUND

Drapery

I_Sistema per tende manuali a strappo. Le tende sono realizzate con tessuti acustici Snowsound Fiber e aricchiate con ricchezza da 1,9 a 2,1. I binari, realizzati in alluminio, possono essere fissati direttamente a parete/soffitto oppure sospesi a soffitto tramite appositi supporti.

EN_Manual curtain system, operated through fabric pulling. The curtains are made with Snowsound Fiber acoustic fabrics using a fabric consumption between 1.9 and 2.1 times the length. The aluminium tracks can be fixed directly to the wall/ceiling or suspended from the ceiling using specific supports.

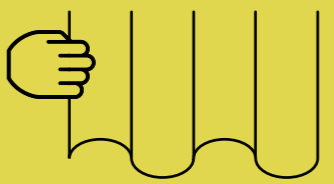

Drapery:

CEILING



- I_ • Larghezza binario da 70 cm a 280 cm, i binari sono giuntabili fino a 840 cm.
- Disponibile per tende con piega piatta, ondulata oppure ondulata bifacciale.
- EN_ • Track width from 70 cm to 280 cm, rails can be joined up to 840 cm.
- Available for inverted pleat, ripple fold or double-face ripple fold curtains.

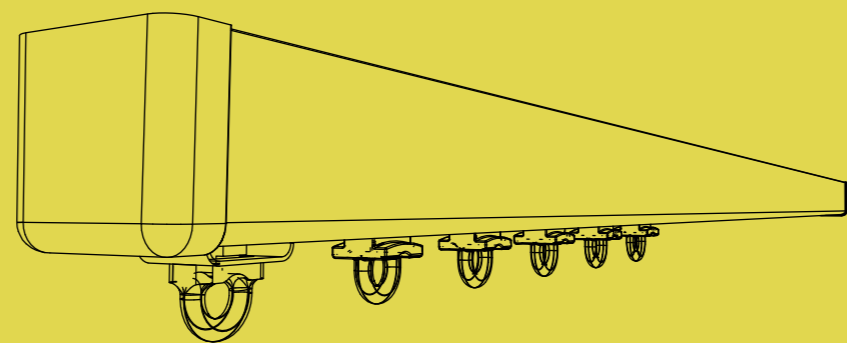

Drapery:

WALL



- I_ • Larghezza binario da 70 cm a 280 cm, i binari sono giuntabili fino a 840 cm.
- Disponibile per tende con piega piatta, ondulata oppure ondulata bifacciale.
- EN_ • Track width from 70 cm to 280 cm, rails can be joined up to 840 cm.
- Available for inverted pleat, ripple fold or double-face ripple fold curtains.

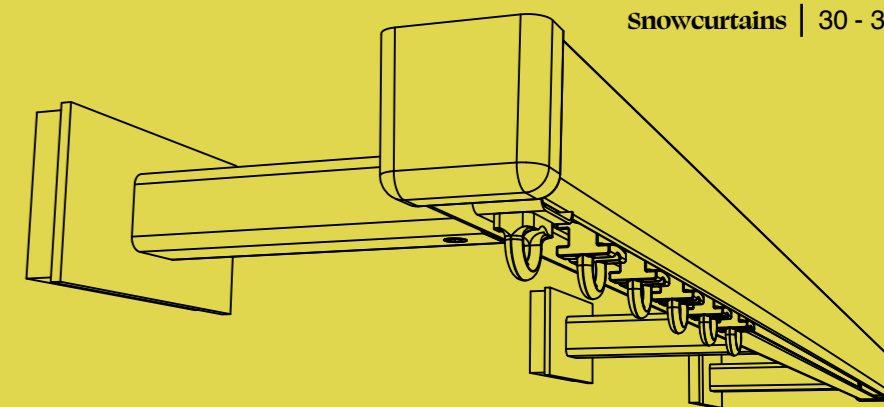

**BINARIO
RAIL**

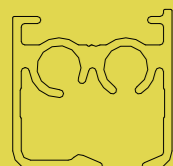

**SUPPORTO
SUPPORT**

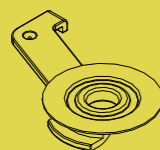

**APPLICAZIONE
APPLICATION**

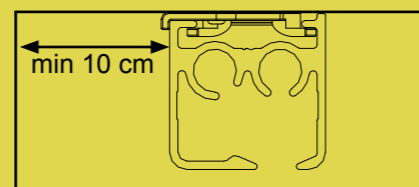

**BINARIO
RAIL**

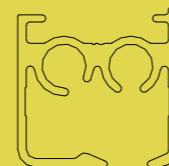

**SUPPORTO
SUPPORT**

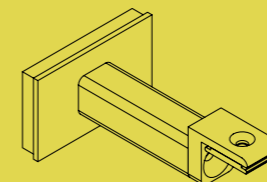

**APPLICAZIONE
APPLICATION**

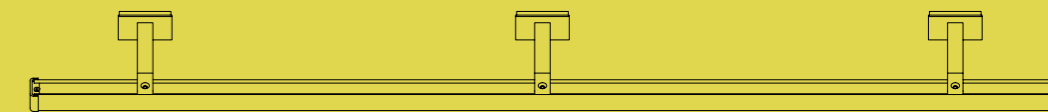
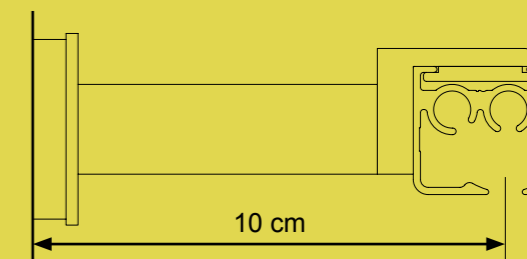

Drapery:

SUSPENDED



- I_** • Larghezza binario da 70 cm a 280 cm, i binari sono giuntabili fino a 840 cm.
 - Supporti a soffitto con H min 12 max 100 cm.
 - Disponibile solo per tende con piega ondulata e ondulata bifacciale
- EN_** • Track width from 70 cm to 280 cm, rails can be joined up to 840 cm.
 - Ceiling supports H min 12 max 100 cm.
 - Available for ripple fold or double-face ripple fold curtains.

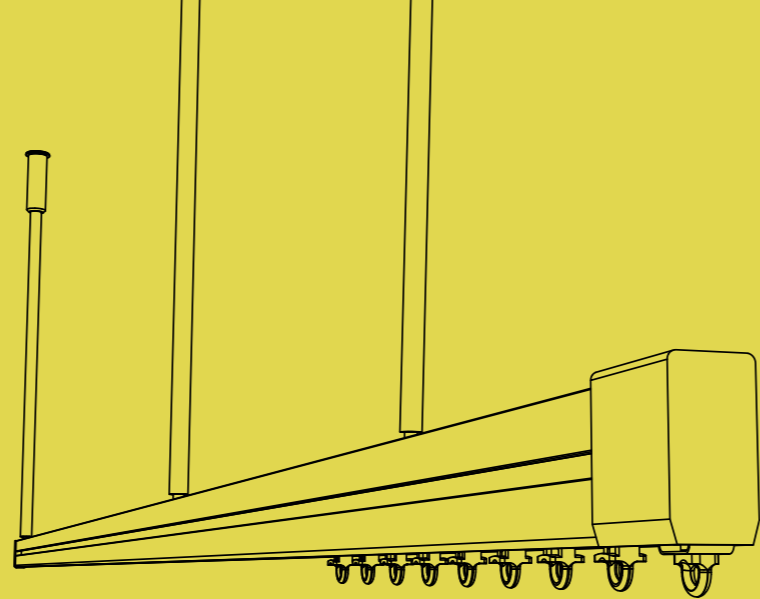

BINARIO
RAIL

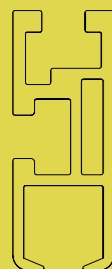

SUPPORTO
SUPPORT



12 ÷ 100 cm

ATTACCO A PARETE (incluso)
WALL-FIXING (included)

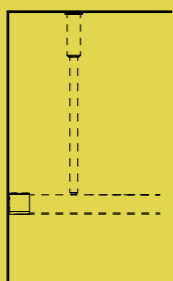

APPLICAZIONE
APPLICATION

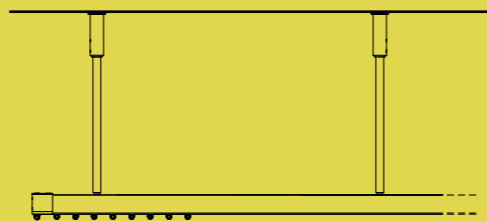

SNOWSOUND

Drapery:

WALL/CEILING/SUSPENDED

APERTURA TENDA
CURTAIN OPENING

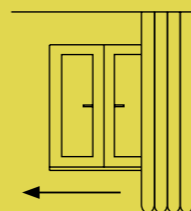
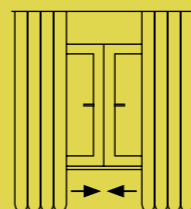
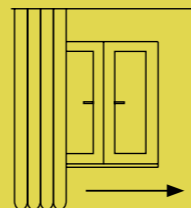

PIEGA TENDA
CURTAIN PLEAT

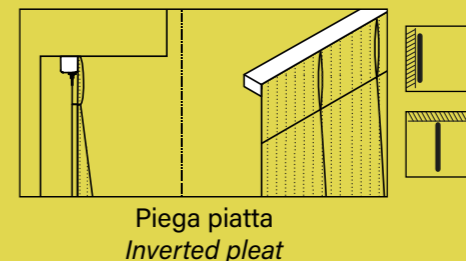

Piega piatta
Inverted pleat

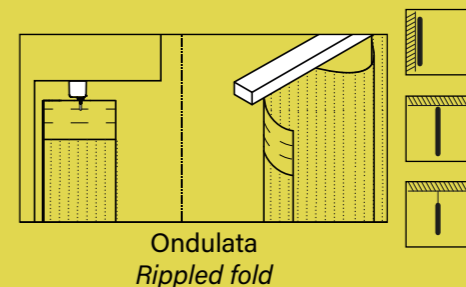

Ondulata
Rippled fold

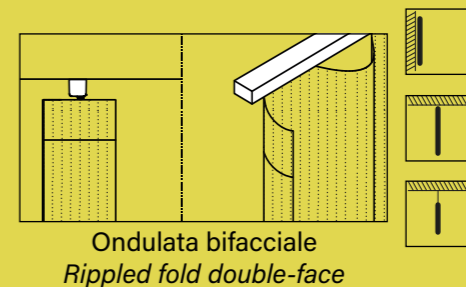

Ondulata bifacciale
Rippled fold double-face

FINITURE BINARIO E SUPPORTI
RAIL AND SUPPORTS FINISHES



RAL 9010



RAL 9000



Aluminium

Inspirations



>> A quieter workspace equals better work



GENSLER, Miami (U.S.A.)

FIBER 3

SNOWSOUND





SNOWSOUND

BMW, Milano (Italy) _ FIBER 6



CONVEY, Miramar (U.S.A.)

FIBER 3

>> Find acoustic privacy in a noisy space



OFFICE

FIBER 3

SNOWSOUND

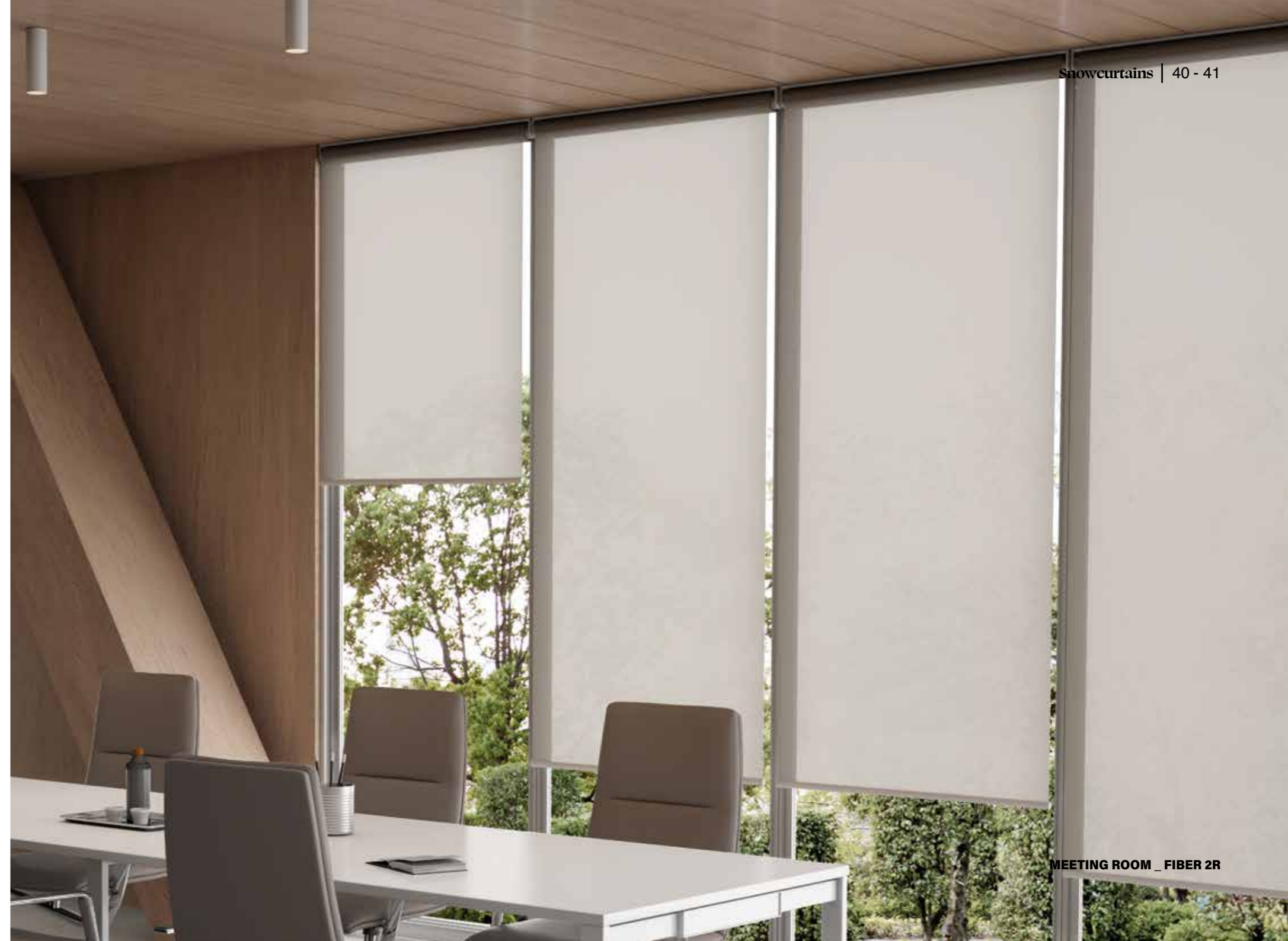

MEETING ROOM _ FIBER 2R



SNOWSOUND



THE SPLASH LAB (U.S.A.)

FIBER 3

>> Hear better to
understand better



UNIVERSITÀ BOCCONI, Milano (Italy)

FIBER 2

SNOWSOUND



IDENTITÀ GOLOSE, Milano (Italy) _ FIBER 2

>> Hear
better to
learn more

SNOWSOUND

TRAINING ROOM _ FIBER 8

MAXXI, Roma (Italy) _ FIBER 2

>> Great performance requires acoustic comfort



THEATER, Lido di Venezia (Italy)

FIBER 6

SNOWSOUND



NEW HORIZON SCHOOL (U.S.A) _ FIBER 6

>> A comfortable hotel while travelling



HOTEL ROOM

FIBER 3

SNOWSOUND



HOTEL ROOM _ FIBER 6 / FIBER 2



SNOWSOUND

HOTEL LOUNGE _ FIBER 6

>> Acoustic
comfort
hidden in
a curtain



Snowcurtains | 52 - 53

SUPERHOTEL, Milano (Italy) _ FIBER 2



SNOWSOUND

RESTAURANT CHAÏ (Belgium) _ FIBER 3

>> Tastes
good,
sounds
good



FRAGRANZE PIZZERIA, Chieti (Italy) _ FIBER 6

>> Home quiet home



LIVING ROOM

FIBER 7

SNOWSOUND



BEDROOM _ FIBER 2R



SNOWSOUND

HOME OFFICE _ FIBER 8



LIVING ROOM

FIBER 8

Textile finishes

Fiber 7

VELO - ACOUSTIC TEXTILES

I_Tessuto acustico leggero e semi-trasparente, satinato e brillante, caratterizzato da una texture fine in tinta unita o con lievi fiammature di colore. L'effetto "VELO" elimina le barriere visive tra outdoor e indoor oppure tra gli spazi interni di uno stesso ambiente. Realizzato in poliestere riciclabile al 100%. Fiber 7 ha Classe di reazione al fuoco Euroclass B-s1, d0.

EN_A light, semi-transparent acoustic fabric, satiny and shiny, characterised by a fine texture in solid colours or with slight flashes of colour. The 'VELO' effect eliminates visual barriers between outdoor and indoor or between interior spaces in the same room. Made of 100% recyclable polyester. Fiber 7 has Euroclass B-s1, d0 classification as to reaction to fire.

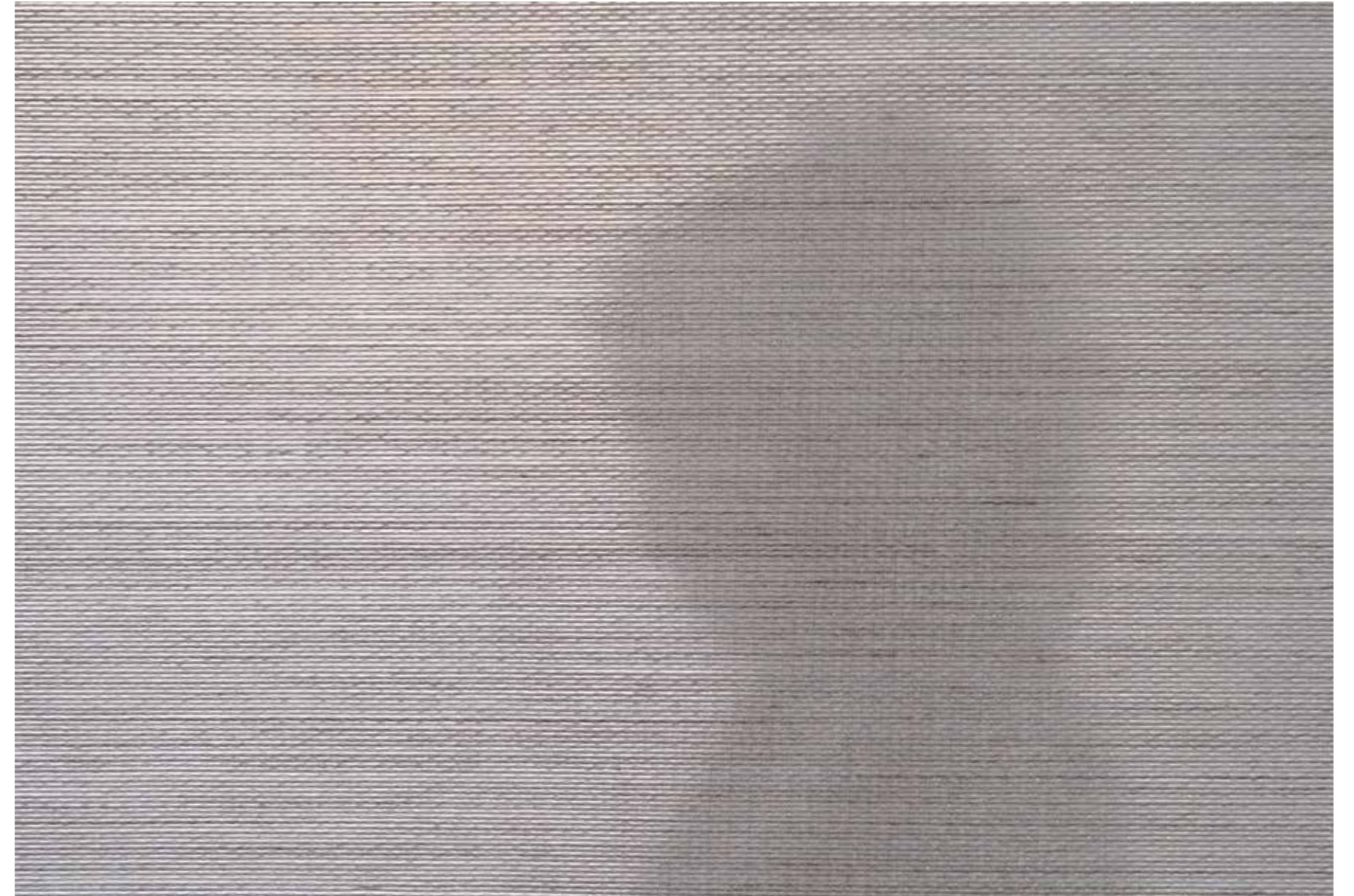
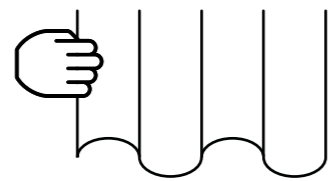

Acoustic Textiles:
FIBER 7



Colour 702

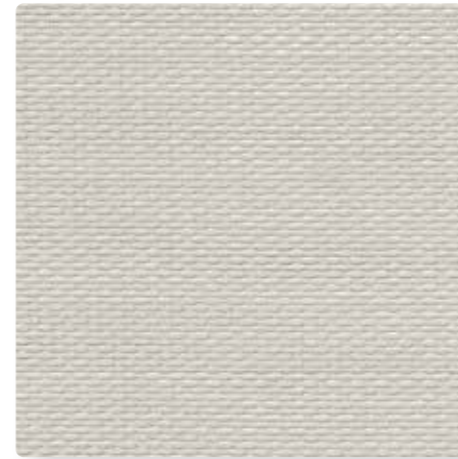

Colour 701

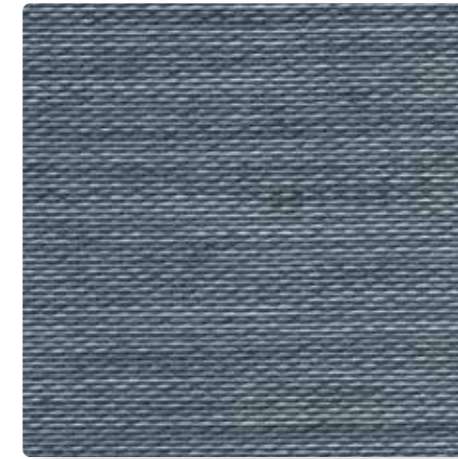

Colour 703

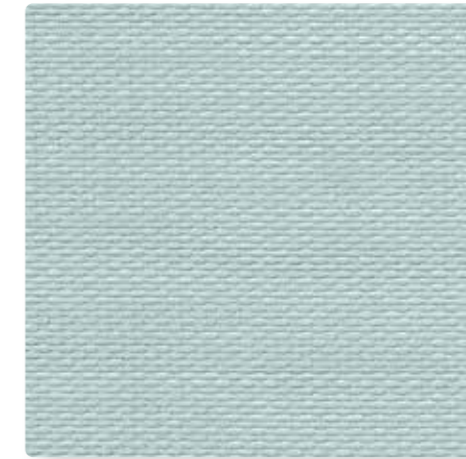

Colour 707

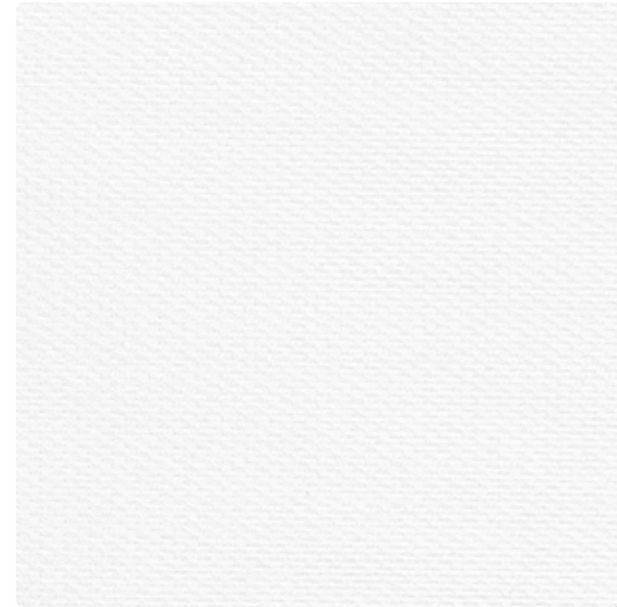

Colour 700



Colour 704

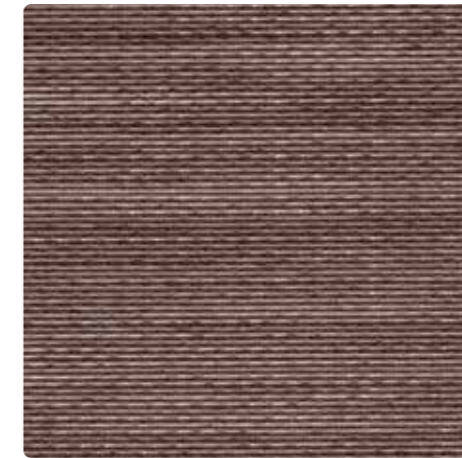

Colour 705



Colour 706

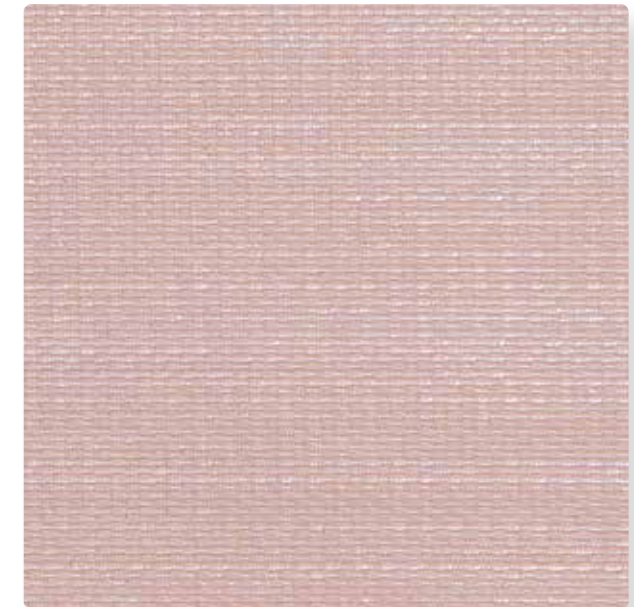

Colour 708

Fiber 2

LINE - ACOUSTIC TEXTILES

I_Tessuto acustico leggero in tinta unita con armatura millerighe a piccoli rilievi che generano una rigatura molto fine. Realizzato in poliestere riciclabile al 100%. Fiber 2 ha Classe di reazione al fuoco Euroclass B-s1, d0.

EN_Light acoustic fabric in solid colour with a needlecord look with small reliefs that generate a very fine stripe pattern. Made of 100% recyclable polyester. Fiber 2 has Euroclass B-s1, d0 classification as to reaction to fire.

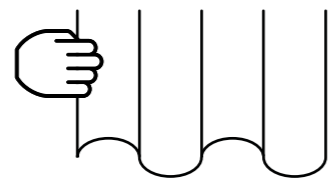

Fiber 2R

LINE-R - ACOUSTIC TEXTILES

I_Tessuto acustico leggero in tinta unita con armatura millerighe a piccoli rilievi che generano una rigatura molto fine. Studiato per tende a rullo. Realizzato in poliestere riciclabile al 100%. Fiber 2R ha Classe di reazione al fuoco Euroclass B-s1, d0.

EN_Light acoustic fabric in solid colour with a needlecord look with small reliefs that generate a very fine stripe pattern. Designed for roller blinds. Made of 100% recyclable polyester. Fiber 2R has Euroclass B-s1, d0 classification as to reaction to fire.

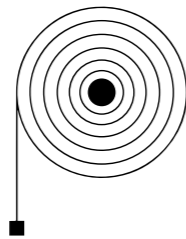

FIBER 2 / 2-R



Colour 200

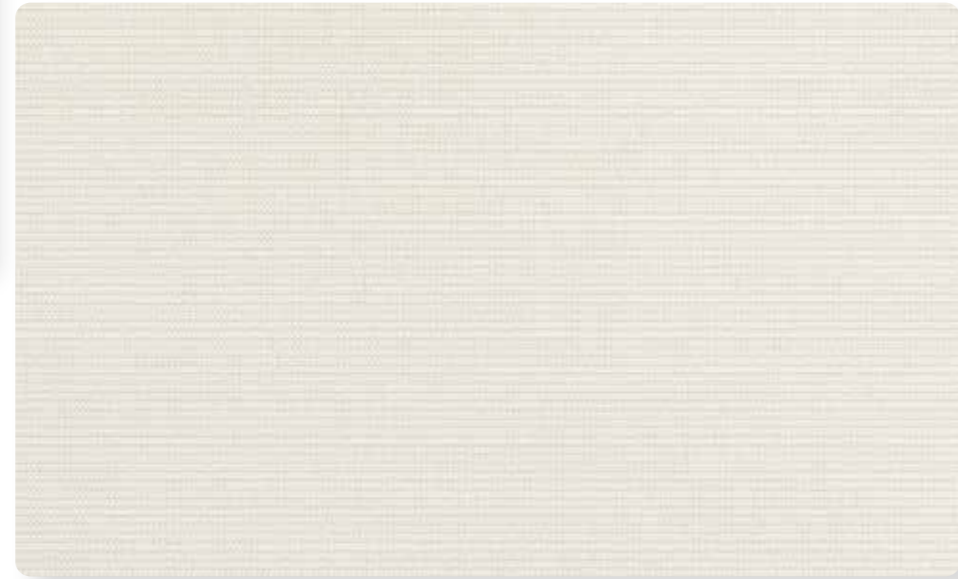

Colour 201

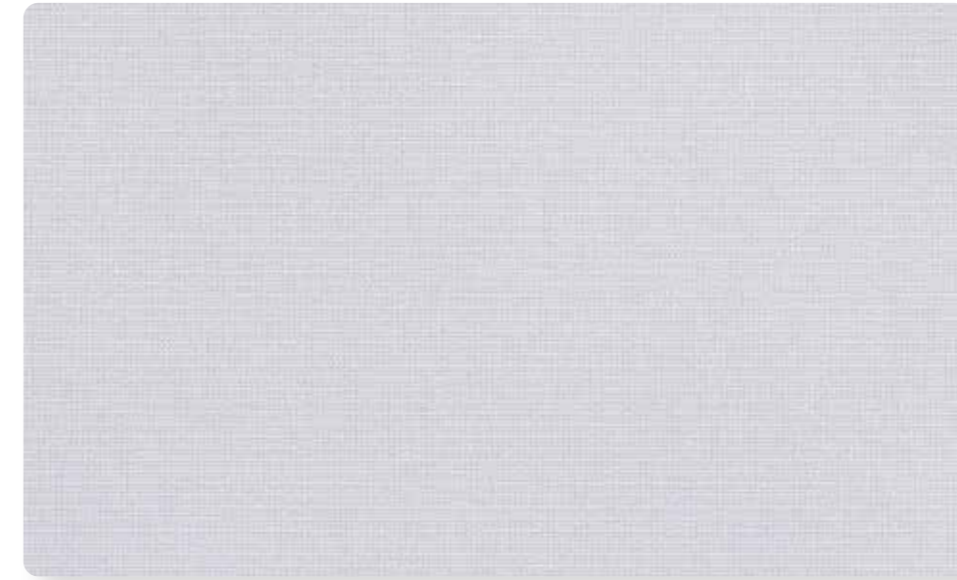

Colour 202

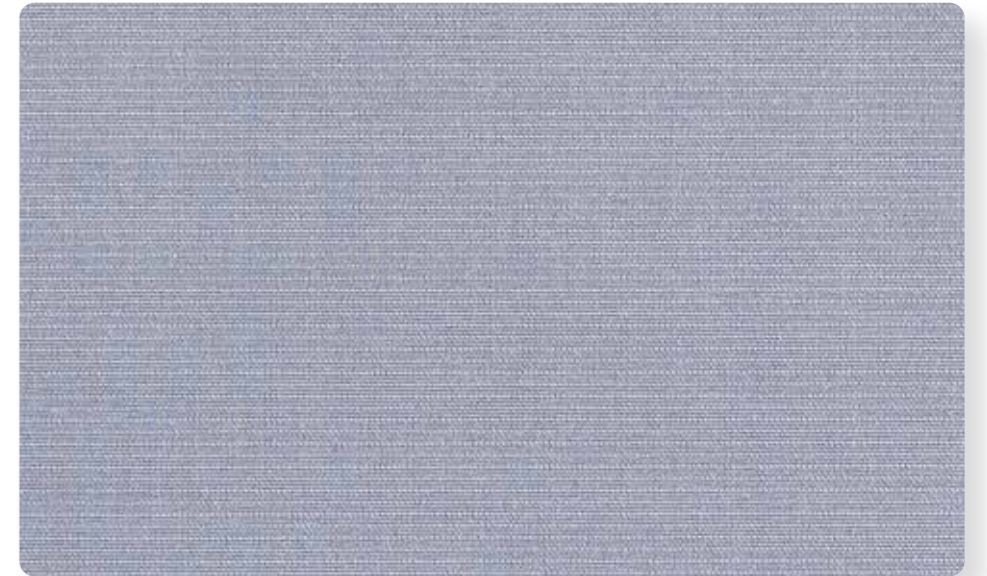

Colour 203

Fiber 3

MELANGE - ACOUSTIC TEXTILES

I_Tessuto acustico mano "lana", ottenuto dall'insieme di filati composti da fibre melange. Il tessuto non presenta una direzione precisa e questo permette di lavorarlo e tagliarlo secondo diverse forme. Realizzato in poliestere riciclabile al 100%. Fiber 3 ha Classe di reazione al fuoco Euroclass B-s1, d0.

EN_Acoustic "wool" finish woven fabric, obtained from the set of yarns composed of mélange fibres. The fabric does not have a precise direction and this allows to work and cut it according to different shapes. Made of 100% recyclable polyester. Fiber 3 has Euroclass B-s1, d0 classification as to reaction to fire.

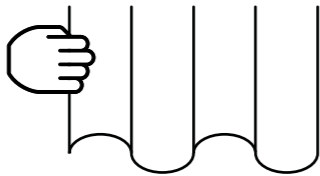

Acoustic Textiles:
FIBER 3

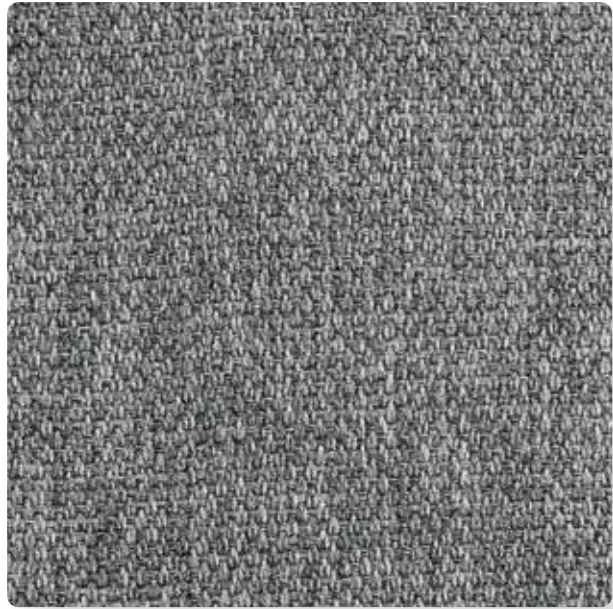

Colour 300

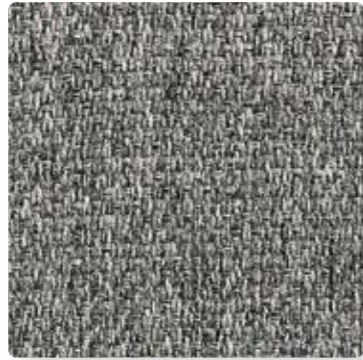

Colour 304



Colour 305



Colour 303

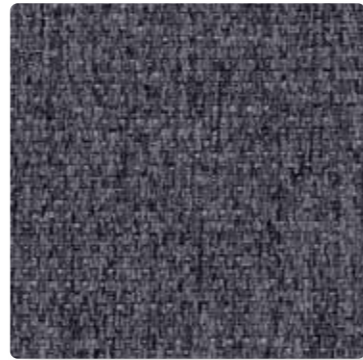

Colour 311



Colour 302



Colour 309



Colour 315



Colour 314

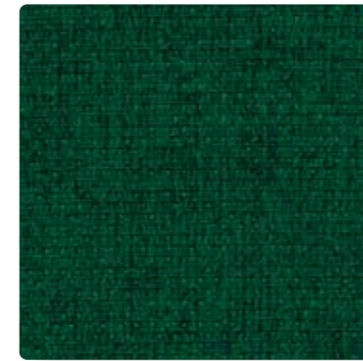

Colour 313



Colour 310



Colour 308



Colour 312



Colour 307



Colour 306

Fiber 8

BOUCLÉ - ACOUSTIC TEXTILES

I_Tessuto acustico con differenti texture sui due lati: un lato caratterizzato dai tipici "ricciolini" del bouclé che generano effetti lucido/opaco e un lato più tecnico e rasato. Realizzato in poliestere riciclabile al 100%. Fiber 8 ha Classe di reazione al fuoco Euroclass B-s1, d0.

EN_Acoustic fabric with different textures on both sides: one side characterised by the typical 'curls' of bouclé that generate shiny/matt effects and a more technical, shaved side. Made of 100% recyclable polyester. Fiber 8 has Euroclass B-s1, d0 classification as to reaction to fire.

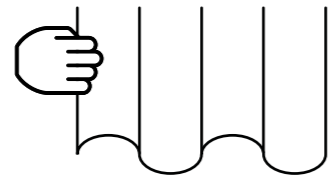

Acoustic Textiles:
FIBER 8



Colour 801

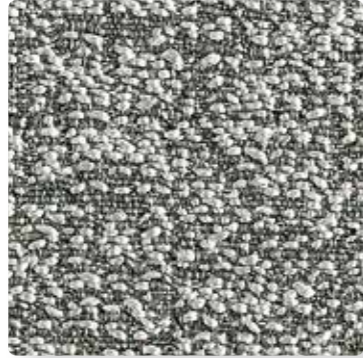

Colour 802

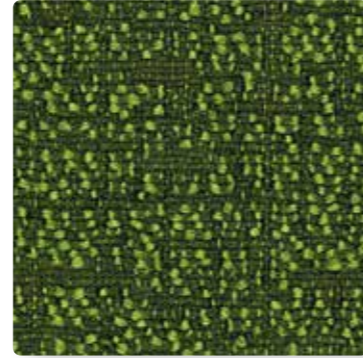

Colour 804



Colour 800



Colour 807



Colour 803

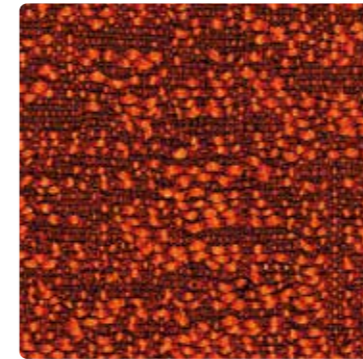

Colour 809

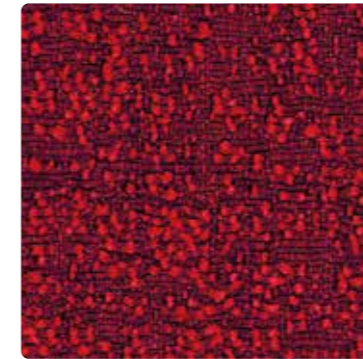

Colour 808



Colour 805

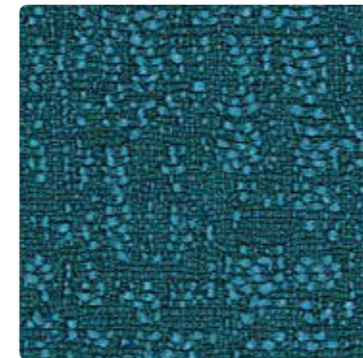

Colour 806

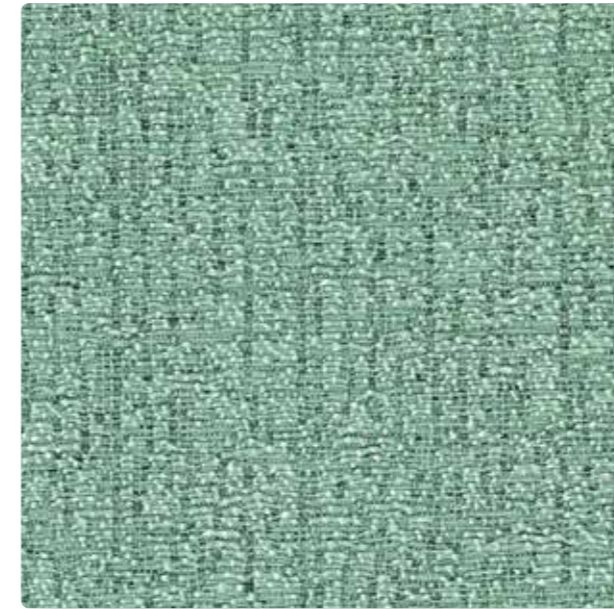

Colour 815

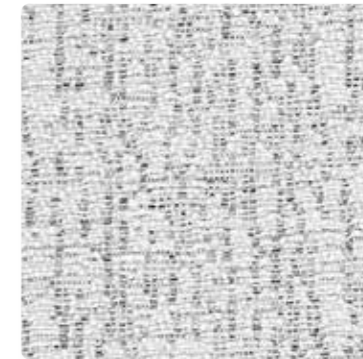

Colour 810

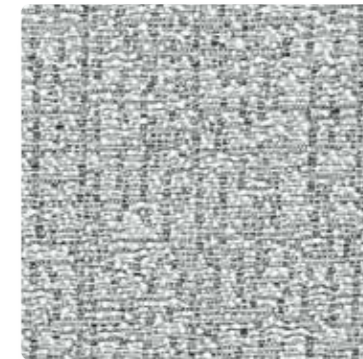

Colour 811



Colour 814



Colour 813

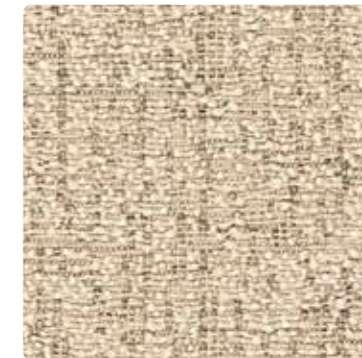

Colour 812

Fiber 6

VELVET - ACOUSTIC TEXTILES

I_Tessuto acustico morbido e corposo mano "velluto" ottenuto con filati di ciniglia che generano una texture fiammata, brillante, con lievi effetti chiaro-scuro. Realizzato in poliestere riciclabile al 100%. Fiber 6 ha Classe di reazione al fuoco Euroclass B-s1, d0.

EN_A soft, full-textured acoustic 'velvet' fabric made from ciniglia yarns that generate a flamed, shiny texture with slight light-dark effects. Made of 100% recyclable polyester. Fiber 6 has Euroclass B-s1, d0 classification as to reaction to fire.

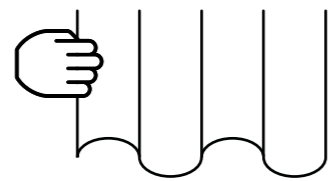

Acoustic Textiles:
FIBER 6



Colour 604



Colour 605

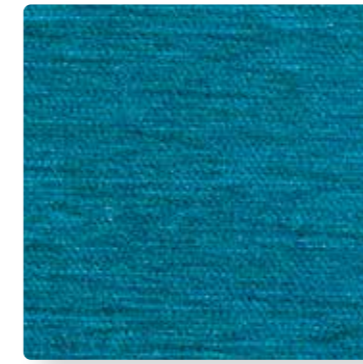

Colour 603



Colour 611

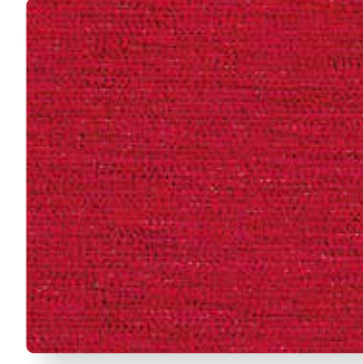

Colour 600



Colour 601



Colour 602



Colour 609



Colour 610



Colour 606



Colour 607



Colour 608

SNOWSOUND

LEGENDA / SYMBOLS

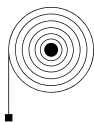

I_Tende a rullo.
EN_Roller shades.

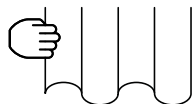

I_Tende manuali a strappo.
EN_Manual curtain system (drapery).

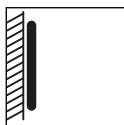

I_Tende manuali a strappo fissate a parete.
EN_Wall-mounted manual curtain system.

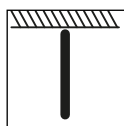

I_Tende manuali a strappo fissate a soffitto.
EN_Ceiling-mounted manual curtain system.

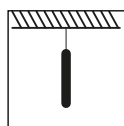

I_Tende manuali a strappo pendinate.
EN_Suspended manual curtain system.

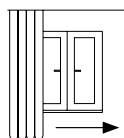

I_Apertura tenda da sinistra.
EN_Curtain opening from the left.

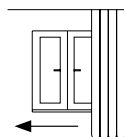

I_Apertura tenda da destra.
EN_Curtain opening from the right.

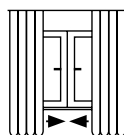

I_Apertura tenda verso il centro.
EN_Curtain opening to the center.

I_Caimi Brevetti S.p.A. si riserva, a proprio insindacabile giudizio, la facoltà di modificare senza preavviso i materiali costruttivi, le caratteristiche tecniche ed estetiche, nonché le dimensioni degli elementi illustrati nel presente catalogo le cui immagini e colori sono puramente indicativi. Il testo facente fede è esclusivamente quello in lingua italiana, le traduzioni hanno la finalità esclusiva di semplificarne la lettura. Prima di procedere all'acquisto dei prodotti illustrati nel presente catalogo consultate le condizioni di vendita nonché le caratteristiche tecniche e le avvertenze riportate nel listino prezzi in vigore.

EN_Caimi Brevetti S.p.A. reserves, by its unappealable judgment, the right to modify without prior notice the building materials, the technical and aesthetic specifications, as well as the dimensions of the products in this catalogue, where pictures and colours are purely as an indication. The authentic text is only in Italian, the translation has the mere purpose of simplifying the reading. Prior to purchasing the products in this catalogue please consult the sale conditions and also the technical specifications and warnings in the current price list.

CAIMI BREVETTI S.p.A.

Via Brodolini, 25/27
20834 Nova Milanese - MB - Italy
Tel. 0362 49101
info@caimi.com
www.caimi.com

UFFICIO VENDITE ITALIA

Tel. 0362 491001
Fax 0362 491060
vendite.italia@caimi.com

EXPORT DEPARTMENT

Tel. (+39) 0362 491002
Fax (+39) 0362 491061
export.dept@caimi.com

U.S.A / Canada / Mexico**Snowsound USA**

10018 Santa Fe Springs Road
Santa Fe Springs, CA 90670
Tel. 562.903.9550
info@snowsoundusa.com
www.snowsoundusa.com

Los Angeles Showroom

Helms Design Center
8745 Washington Blvd, Studio C
Culver City, CA 90232 USA

Chicago Showroom

222 Merchandise Mart Plaza
Floor 11, Suite 1197
Chicago, IL 60654 USA

STAMPA

Ingraph Srl

COPYRIGHT

Caimi Brevetti SpA 2023

ARCHIVIO FOTOGRAFICO

Caimi Brevetti SpA

FOTOGRAFIE

Interno20

Federico Campi

Raoul Iacometti

Nube Architetture

Barbara Corsico

